

**WISeNET**

# **DIGITAL VIDEO RECORDER**

Quick Guide

HRX-1635/HRX-1634/HRX-835A

**CE**

## Features

The product records video and audio from cameras to a hard disk, and enables playback from the hard disk. It also provides remote monitoring environment for video and audio over the network using a remote computer.







- Provides new UI 2.0
- Supports instant viewer
- Bookmark function
- Thumbnail function (Not supported in web viewer)
- View camera event list in real time
- Convenient event rule setup
- Various sequence (layout, page) functions
- Extended search period
- Convenient log search
- Supports thermal imaging camera/PTZ linked camera
- Supports a range of 4K camera resolutions
- Outputs a 4K high definition image using HDMI
- Supports dual monitor output
- Record and play video
- Record and play audio
- Supports ONVIF Profile S standard and RTP / RTSP protocols
- Display the HDD operation status by HDD SMART
- HDD overwrite enabled
- Function to export using USB memory and external hard disk
- Simultaneous play of 10 or 18 channels
- View multi-channel time line when playing videos
- Various Search Modes (Time, Event, Smart, Text, Export, ARB)
- ARB support (configuration feature for saving period by channel)
- Various recording modes (Normal, Event, Scheduled Recording)
- Alarm Input / Output
- Remote monitoring function by Windows Network Viewer
- Live monitoring of the camera
- Installation Wizard Function (Recorder, Web Viewer)
- Supports the remote monitoring feature by DDNS/P2P support (Wisenet Viewer/Wisenet mobile)
- Provides smartphone event alarm (sending real-time event messages)





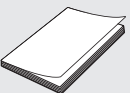

## Package Contents

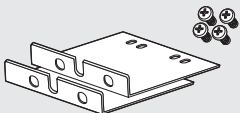
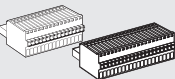

- The appearance of the components may differ from the image shown.
- Accessory category and quantity may differ depending on sales region.
- For some regions, HDD is not pre-installed. HDD Fixing Screw, SATA Cable quantity vary depending on the model.

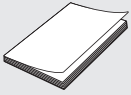
### HRX-1635/HRX-835A

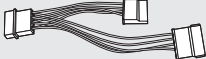
		
Recorder	Mouse	Quick Guide
		
Power Cable	SATA Power Cable	SATA Data Cable (HRX-1635: 8 ea, HRX-835A: 4 ea)
		
HDD Fixing Screw (HRX-1635: 32 ea, HRX-835A: 16 ea)	Bracket Rack (2 ea)/Screw(4 ea)	Terminal block (15 pins, 20 pins)

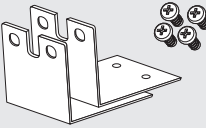
		
Recorder	Mouse	Quick Guide
		
Power Cable	Power Adaptor	SATA Power Cable
		
SATA Data Cable (2 ea)	HDD Fixing Screw (8 ea)	Bracket Rack (2 ea)/Screw(4 ea)

## Installing the HDD

-  ■ If you are adding a new or previously used HDD to this product in addition to the HDD(s) originally installed, format the new HDD manually in the set before use.
- If you wish to replace or add an HDD, contact your dealer or our customer service first.

### HRX-1635/HRX-835A

-  ■ The images below are based on the HRX-1635 model.

- 1** Loosen the screws on the left/right sides and back and slide the cover back to remove it.

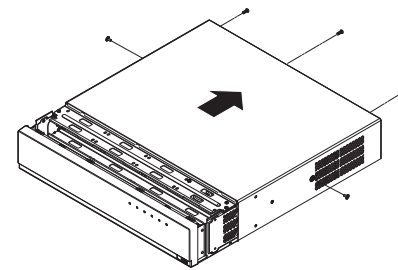

- 2** Loosen the left/right screws and remove the bracket.

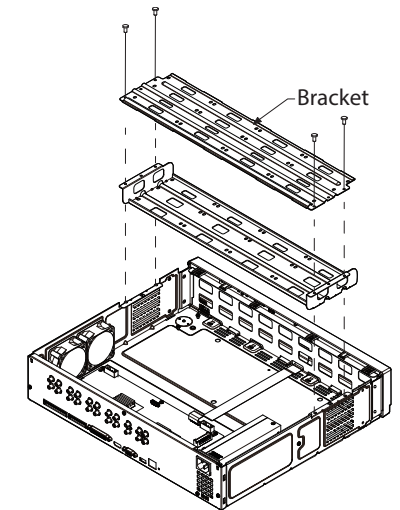

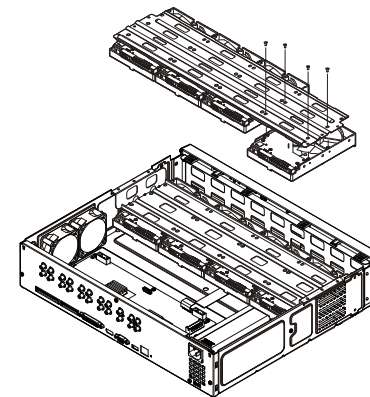

- 3** Install 8 HDDs to the bracket and fix them with screws.

- For the HRX-835A, install the HDD only to the bottom bracket.

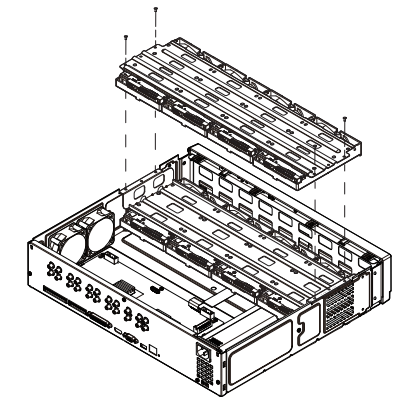

- 4** Fix the bracket with the HDD to the recorder with screws.



-  ■ To prevent damage to the HDD(s) due to vibration, it is recommended to install it first to the bottom bracket.

**5** Connect the SATA/power cable of the HDD to the connector on the motherboard.

- Refer to the figure below for the location/connector number of the HDD.

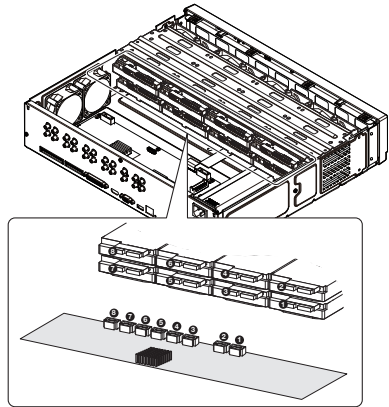

**6** After making sure that there is no problem with the connection terminal and wiring inside the product, close the cover and fix it with screws.

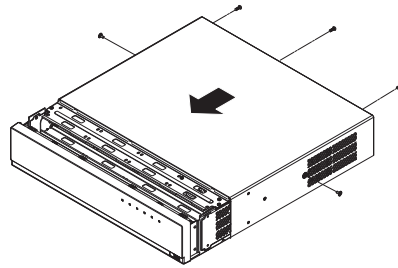

## HRX-1634

**1** Loosen the screws on the left/right sides and back and slide the cover back to remove it.

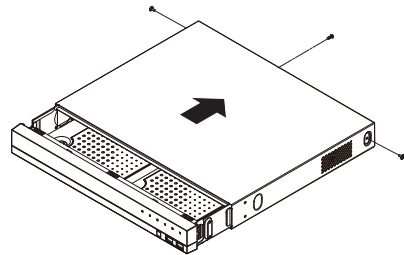

**2** Connect the SATA/power cable of the HDD to the connector on the motherboard.

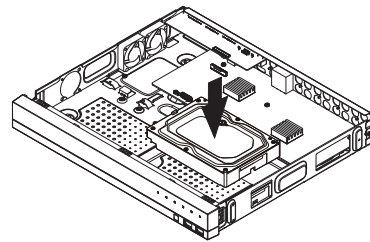

**3** Fix the HDD to the bottom of the recorder with screws.

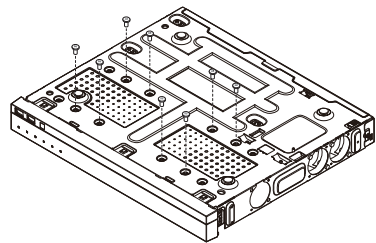

**4** Check if there is any problem with the connection terminal and wiring inside the product.

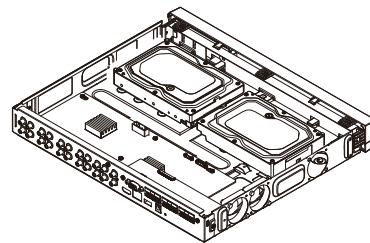

**5** Close the cover and secure it with screws.

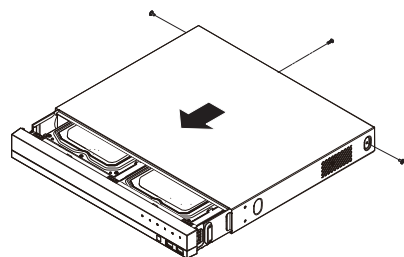

## Installation Wizard Setup

As shown below, proceed through each step of the <Installation wizard>. Install Wizard can only be accessed at factory reset. If you do not want to proceed, click <Exit>.



- You can set the installation wizard on the recorder and web viewer. Refer to the User Manual for instructions on how to set up the installation wizard on the web viewer.
- When you complete installation using the installation wizard on your recorder, the installation wizard will not appear on your web viewer.

### 1 Select the language

Select your preferred language.

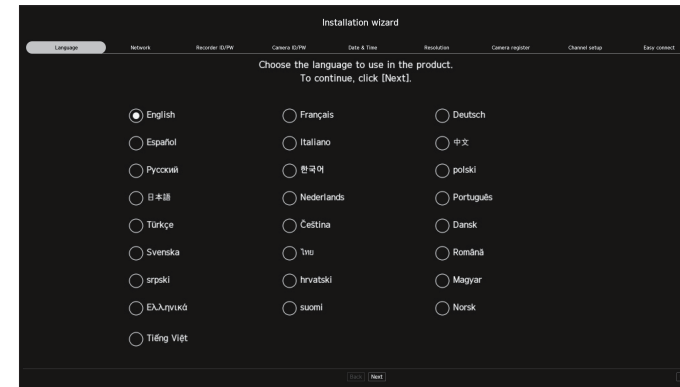

### 2 Network Settings

- DHCP server : If the DHCP server is set to enable, an IP is automatically assigned to the camera.
  - Network : This can be used as a common port for the connection of the camera and web viewer.
  - Network Setup
    - IP Type : Choose the network connection method.
    - IP Address, Subnet Mask, Gateway, DNS
  - Enable online upgrade
    - You can receive a new firmware notification when your recorder is connected to a network.
- ※ For more details on network settings, refer to the User manual.
- ▶ To use a simple intranet, click <Next>.

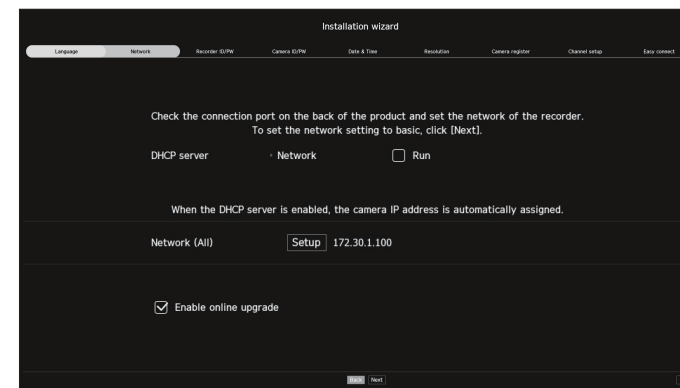

### 3 Recorder ID/PW Setup

Sets the administrator's password.

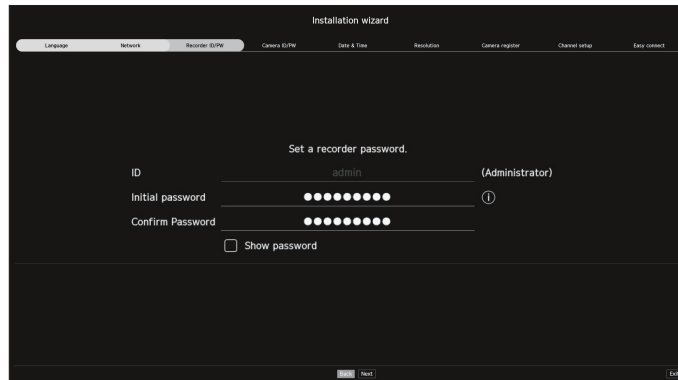

※ Click < i > to view the basic guide for setting a password. Refer to the password setup rules.

### 4 Camera ID/PW Setup

4-1. Set a camera password in factory reset. The initial password for the camera must be entered.

4-2. If ID/PW is already set in the camera, register the ID/PW and click <Next>.

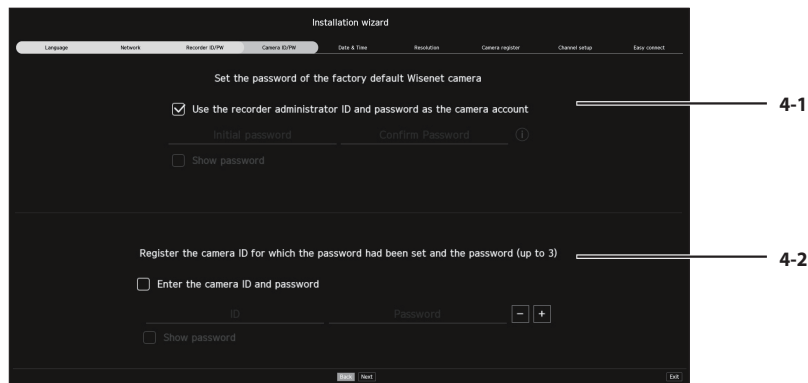

※ Click < i > to view the basic guide for setting a password. Refer to the password setup rules.

※ When the password is in factory reset, it can be changed and managed in a batch.

※ Up to 3 sets of camera ID with password and password can be registered.

※ You may change the passwords of registered cameras all at once in the "Setup > Camera > Camera password" menu.

※ You cannot change the password for cameras registered with ONVIF and RTSP.

### 5 Date & Time Setup

Set the date, time, time zone, and DST and then click <Next>.

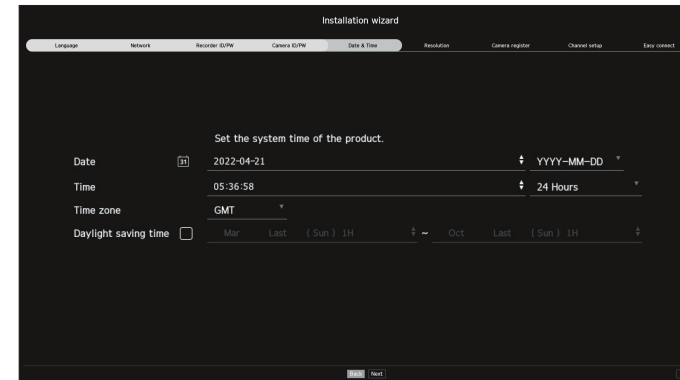

※ The time zone setup might differ depending on the region that the product is released.

### 6 Resolution Setup

To set the recommended resolution, click <Apply> followed by the <Next> button.

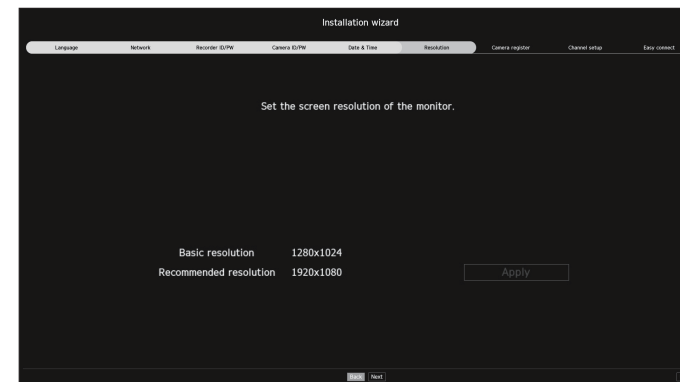

## 7 Camera Register

Registers the searched network cameras.

**7-1** Select a camera to register from the searched camera list and click **<Register>**.

**7-2** Select a camera to register from the list and click **<Change IP>**.

**7-3** After completing camera register, click **<Next>**.

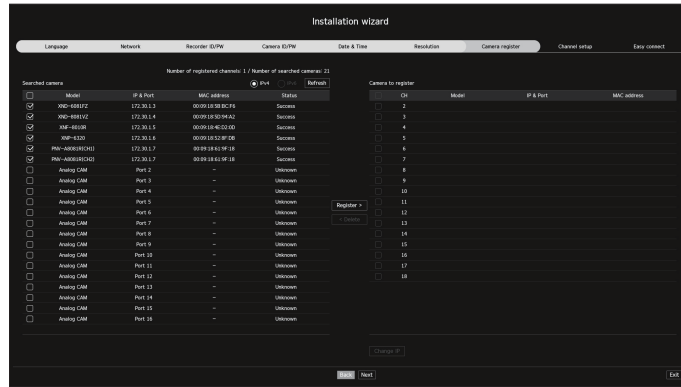

## 8 Channel Setting

You can view the camera videos registered to each channel in split mode along with thumbnail information.

To change the camera video position, select a video and drag and drop it to the desired location.

After completing channel setup, click **<Next>**.

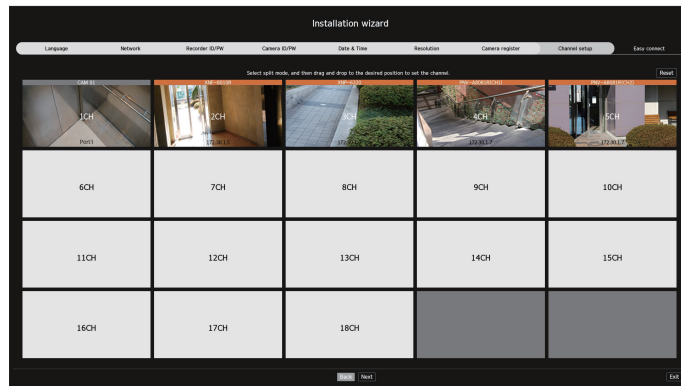

## 9 Easy connect

A remote user can network a recorder in a dynamic IP system.

Click **<Enable>** to test the connection to see if the current recorder can be connected remotely. When the connection is successful, a QR code is created.

To connect a recorder via a viewer, select the viewer you want to use. You can check the connection method of the selected viewer in the popup window.

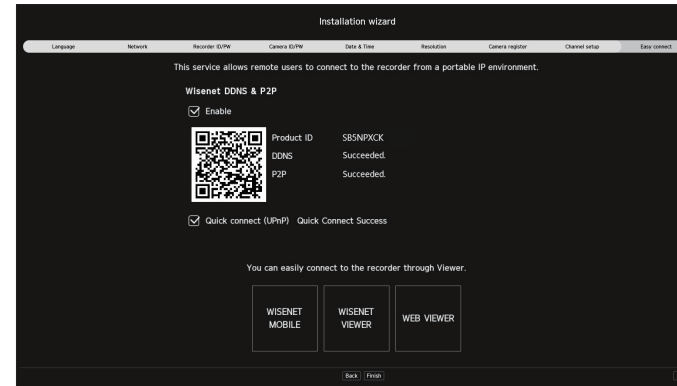

※ It connects to Wisenet DDNS first. If it does not connect to DDNS, it automatically connects to P2P.

**10** Click **<Finish>** to complete the installation wizard.

## Explore Screen Configuration

The recorder screen consists of the following.

- The screen may be configured differently depending on the menu selected by the user.

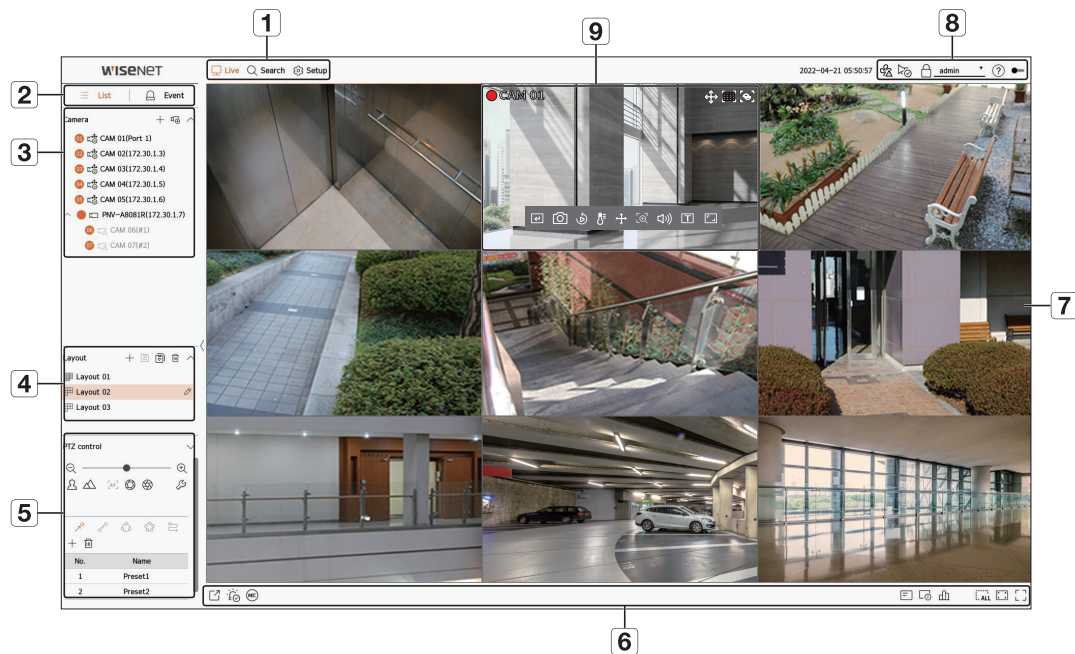

No.	Screen configuration	Detailed description of function
1	Menu	Clicking on each menu takes you to the corresponding menu screen.
2	List/Event	Select to view list of cameras or events.
3	Camera List	Click  List to display list of registered cameras in the recorder. You can also register the camera manually or automatically.
	Event List	Click  Event to display list of events.
4	Layout List	This displays a list of the default layouts and the layouts that have been created. You can set and play sequence on the list of layouts.
5	PTZ Control	Controls the connected PTZ camera.
6	Function Buttons	Function that is frequently or urgently used. (Export, Turn off all notifications, Manual recording, OSD show/hide, Channel info, Status, Remove all tiles, Full aspect ratio, Full screen)
7	Video Window	Shows the video of the camera connected to the recorder.
8	Display System Status and Additional Functions	<ul style="list-style-type: none"> <li>Displays the status of the system, hard disk, and network.</li> <li>Displays the IP address and mutual authentication status of the viewer receiving the video from the recorder.</li> <li>The ID of the connected user is displayed.</li> <li>Displays a QR code to download User Manual.</li> <li>Changes the color theme of the screen.</li> </ul>
9	Display Events and Functions to Control Videos	Displays events that occurred on the camera and functions related to video control.

## Record Setup

You can set resolution, FPS, and quality of recordings by channel, and by recording type of standard / event. You can check frame rates and data transfer amount of Full Frame and Key Frame recordings for each channel, and set the transfer limit for recordings.

### Setup > Record > Record setup

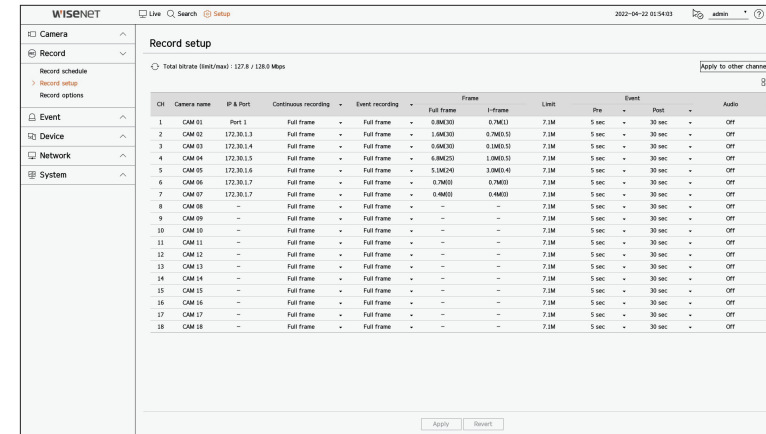

- Apply to other channels : If you select <Apply to other channels>, "Apply to other channels" confirmation window will appear. After selecting channels that the settings will be applied to, click on <OK> to apply them to the selected channels.
- : The camera of the corresponding channel is displayed on the list or as a thumbnail.
- Camera name : Displays the camera name.
- IP & Port : Displays the IP or port location of the camera.
- Continuous recording / Event recording : Set the recording method for Continuous recording or Event recording.
  - Full frame : Records all frames fed by the camera.
  - I-frame : Records only key frames fed by the camera. Depends on camera settings.
  - Off : No recording is made.
- Frame
  - Full frame : Shows the amount of data for all the scene recordings.
  - I-frame : Shows the amount of data for the main scene recordings.
- Limit : Set the amount of data allowed for input for each channel.
- Event : When an event occurs, you can set which point you will start or stop recording.
  - Pre : When an event occurs, recording will be started regardless of the time set. If you set it to five seconds, recording will start at five seconds before an event occurs.
  - Post : When an event occurs, recording will continue after the time set. If you set it to five seconds, recording will continue for a further five seconds after an event is finished.
- Audio : Specify whether to record the sound received from the camera or not.

- If a channel's data transfer exceeds defined allowed limit, then it may affect to other channels, and may force switching to <I-frame> recording even when the channel is configured to <Full frame> recording mode. For Key Frame recording channels, the icon for limited recording appears on the live screen's top side. But if the sum of the limits is below the max limit, you can still receive the entire frames despite exceeding the permitted bitrates for each channel.
- A channel displayed in yellow indicates that the recorded data is not being transferred from the camera and that the recording is being performed temporarily using another profile on the camera. Check the channel information to see the applied profile to the channel listed in yellow. A channel displayed in orange indicates that the amount of inputted data is greater than the permitted data amount. In this case, it is impossible to record all of the incoming frames. Instead, only part of the frames (1 or 2 frames per second) can be recorded. To resolve this issue, you must set the permitted data amount to be greater than the amount of inputted data.

## Set up and Run the Layout

The layout set on the live screen can also be used for time search and can be searched and played according to the channel order and channel combination set by the user.

 For more information on how to set each step, refer to the 'User Manual'.

### 1 Live channel layout setup

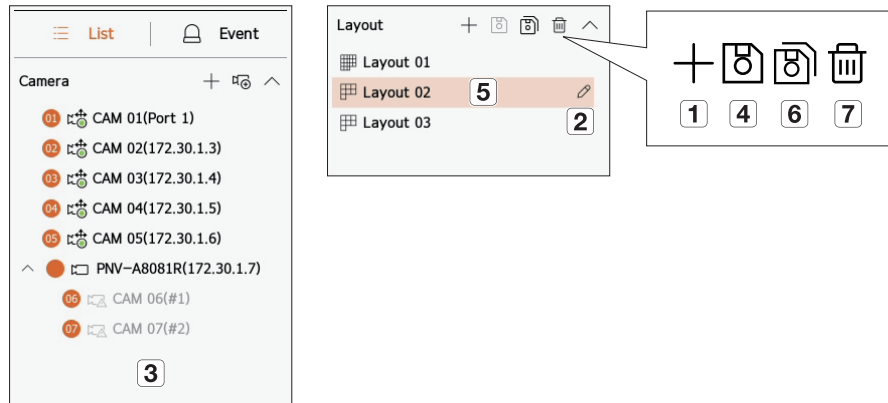

- 1 Add a layout.
- 2 Change layout name.
- 3 Click to select the channel to display on the layout of the camera list.
- 4 Please save the layout you have set up.
- 5 Select a layout to move to the corresponding channel group.
- 6 You can copy the layout. After selecting the layout you want to copy from the list, change the name of the layout and the channel to display.
- 7 You can delete the layout.

### 2 Search/Play

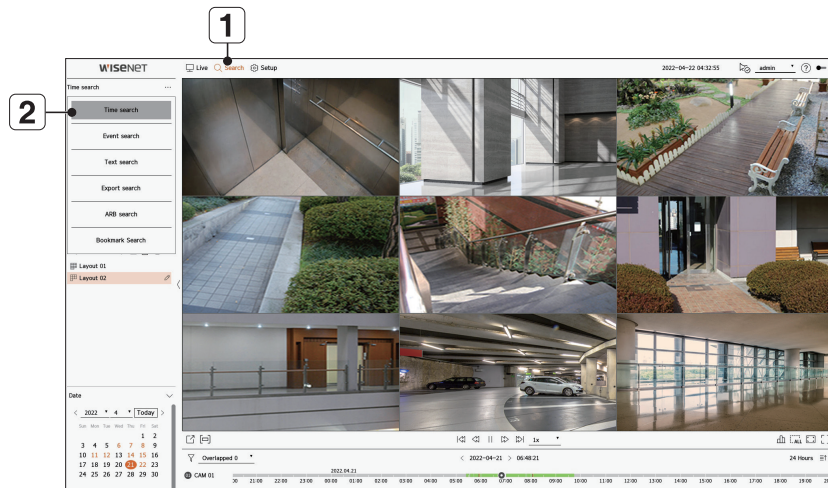

- 1 Click <Search> at the top of the screen.
- 2 Click <Time search>.

### 2-1 Search

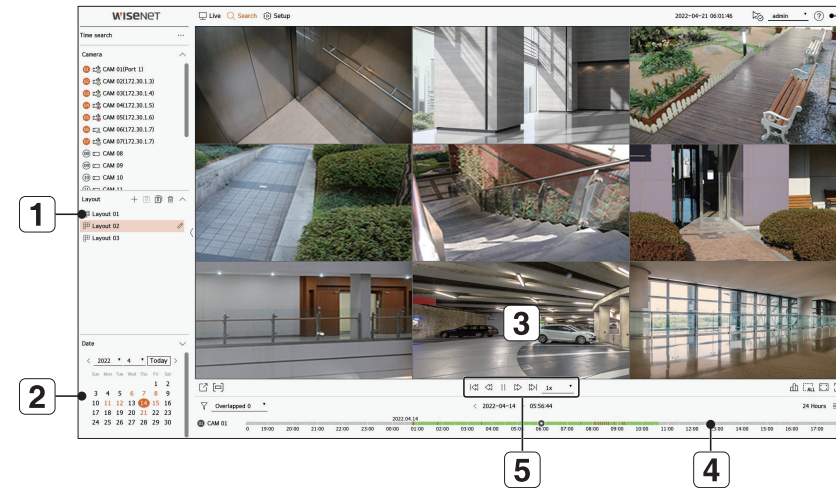

- 1 Select the layout of your choice from the channel groups you created in Live.
- 2 Please select a date to search.
- 3 Select the channel of your choice from the selected channel group.
- 4 You can view the preview screen on figure 3 by moving the time bar.
- 5 Press <▶> to play the selected channel.

### 2-2 Play

When you start playing, the search date and play time are displayed, and you can search for recorded videos while controlling the play speed.



- 1 Control the play speed or move to the previous or next frame.
- 2 Turns the export section setting on or off. You can select a start time and end time for exporting.
- 3 Export the recorded video of a designated time frame for each layout or channel.
- 4 Filter events by type to search for recorded videos.
- 5 Set the overlapping section according to change of time to check the time line.
- 6 Display the time line for each channel.
- 7 Open or close the 4-channel time line.



### 3 Export recorded video



- 1 Click <☐> at the bottom of the screen.
- 2 Select a layout.
- 3 Select a channel.
- 4 Set the time, device, and format for export.
- 5 Click the <Check capacity> button to see if you can export.
- 6 Click the <Start> button to proceed with the export.

### Using Product Information

You can check the product information/manual/firmware information/FAQ/HDD compatibility list on the homepage or mobile web of your smartphone.

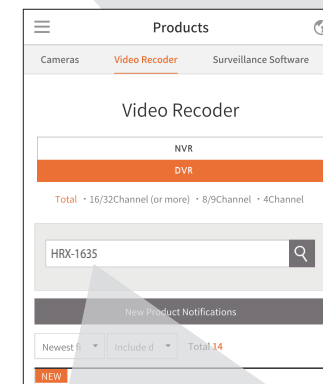
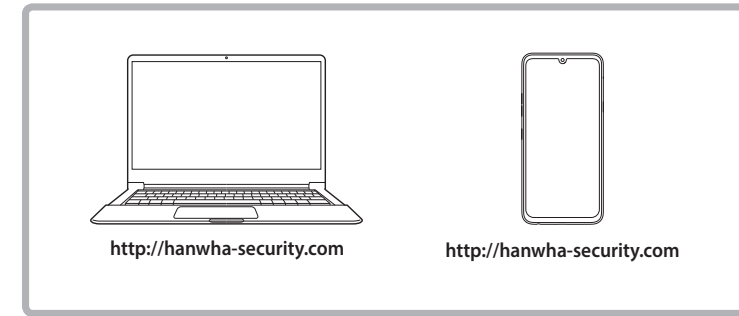

category	file name	Last Updated	
<input type="checkbox"/>	Manuals	User Manual-2016-08-05	2016-08-05
<input type="checkbox"/>	Manuals	User Manual-2016-08-05	2016-08-05
<input type="checkbox"/>	Certification	2014-01-04 C-TICK	2014-01-04
<input type="checkbox"/>	Certification	2014-01-04 FCC	2014-01-04
<input type="checkbox"/>	Certification	2014-01-04 VCCI	2014-01-04
<input type="checkbox"/>	Certification	2014-01-04 UL	2014-01-04
<input type="checkbox"/>	A&E Document	2014-03-06 A&E Doc...	2014-03-06
<input type="checkbox"/>	Firmware	2016-07-01 v2.14 16--	2016-07-01

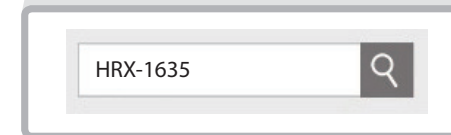

## Using Wisenet DDNS & P2P Service

A remote user can network a recorder using a DDNS address in a dynamic IP system. If you cannot connect with a dynamic IP, you can easily access using a P2P service.

### Accessing using DDNS address in the dynamic IP environment

In the dynamic IP environment such as xDSL/Cable modem, the router's WAN IP can be changed, so we provide DDNS (Dynamic Domain Name Server) service so that you can always access the recorder with only the DDNS address even in the dynamic IP environment.

Before using Wisenet DDNS & P2P, please set up the network connection and DDNS first.

### Setting the Wisenet DDNS & P2P

Click **<Enable>** to test the connection to see if the current recorder can be connected remotely. When the connection is successful, a QR code is created.

- It connects to Wisenet DDNS first. If it does not connect to DDNS, it automatically connects to P2P.

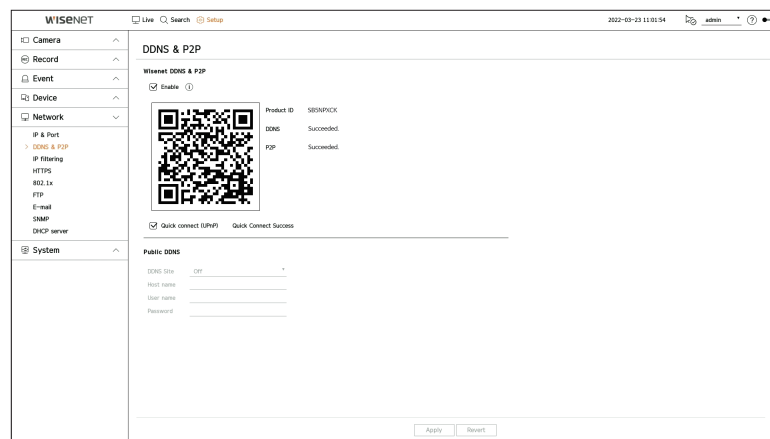

## Connecting to the Viewer

### To connect to the Wisenet mobile from your smartphone

- 1 Install and run the "**Wisenet mobile**" app on your smartphone. You can scan the QR code of the recorder on the **<Add device>** screen.
- 2 When the QR code is scanned, the **<Product ID>** shown in the recorder is automatically reflected in the mobile viewer, and you can use the mobile viewer by entering the recorder ID/password.

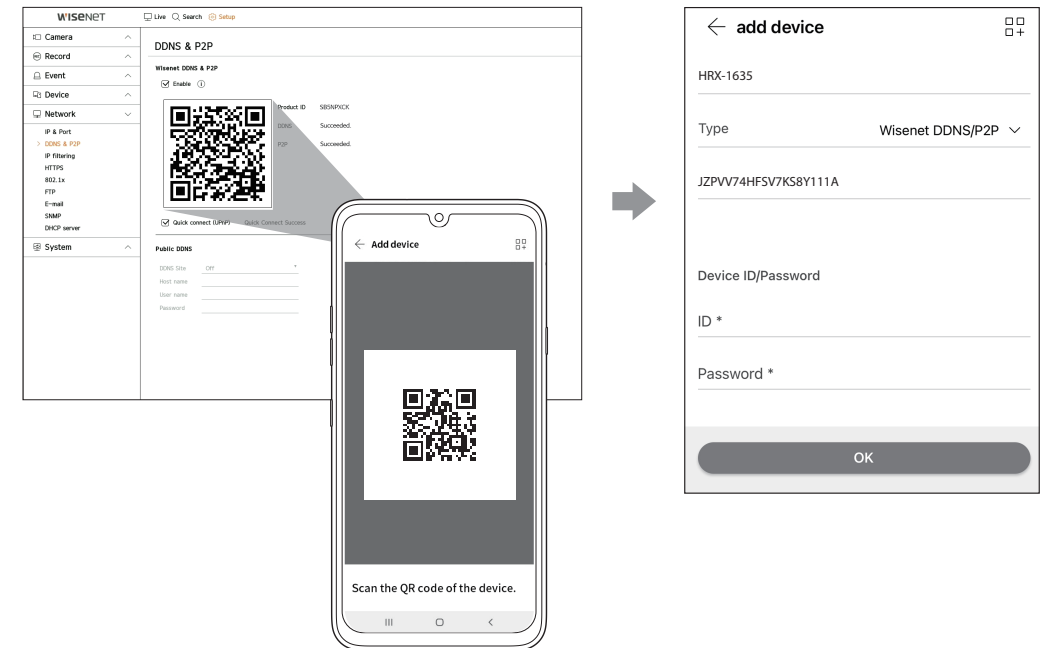

- 3 Then, when you run the "**Wisenet mobile**" app, it will be automatically connected to the recorder and you can monitor it easily with your smartphone.

## To connect to the Wisenet Viewer from your PC

- 1 Go to <https://www.hanwha-security.com> on your PC.  
Install and run the "Wisenet Viewer" app.
- 2 Select <IP type> to <DDNS/P2P> in the "Settings > Device > Device list > Add > Manual" menu.
- 3 Enter the recorder ID/password and <Product ID>, and then click <Register>.  
The information of the current recorder will be displayed, and you can use the "Wisenet Viewer" app.

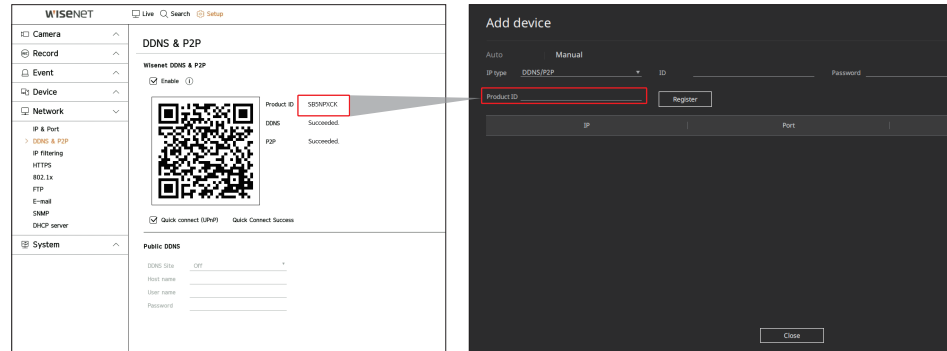

P2P service period expires in 5 years. If you want to extend it after expiration, contact your vendor.

## To connect to the WebViewer from your PC

If you connect to <http://ddns.hanwha-security.com/product ID> including <Product ID> in the local PC address bar, the recorder's web viewer screen will appear.

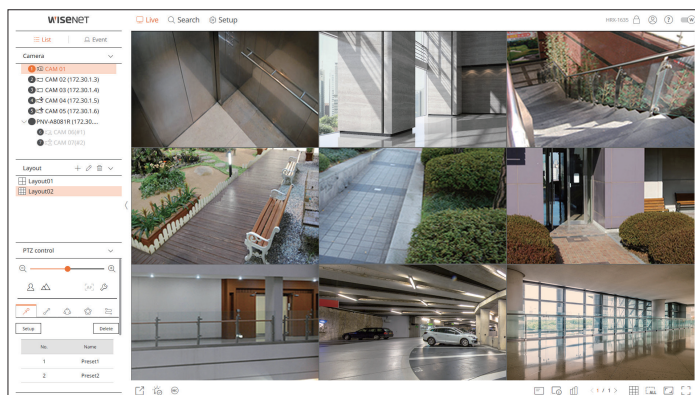
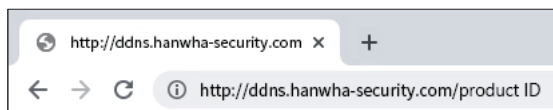

## Connecting to a Network Using a Router

If you want to add 1-3 PCs and recorders in an environment using xDSL/Cable modem, you can use the router with only one Internet line.

This guide is an installation guide for network beginners. Follow the instructions to set up your router, local PC, and recorder.

### Connecting the cable

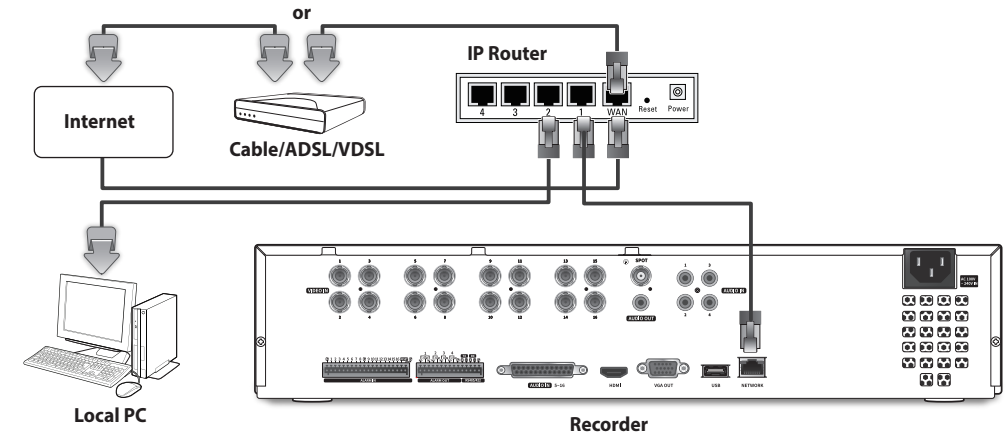

### Connecting a router with PC

Refer to the router's user manual.

### Connecting a recorder and a router

Move to <IP & Port> of the Recorder <Network> Setting menu, and set the ① <IP address> and ② <Gateway> in <Setup>.

※ The <Default gateway> checked on the [cmd.exe] window of the local PC and the <Gateway> of the recorder must be the same.

※ At least the third number of the recorder <IP address> should be set to be the same as the <Default gateway> checked on the [cmd.exe] window of the local PC.

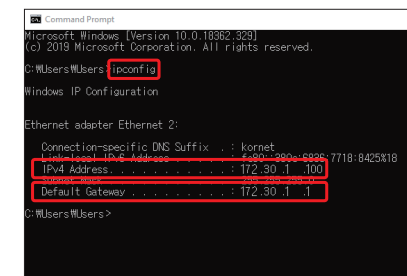

<cmd screen>

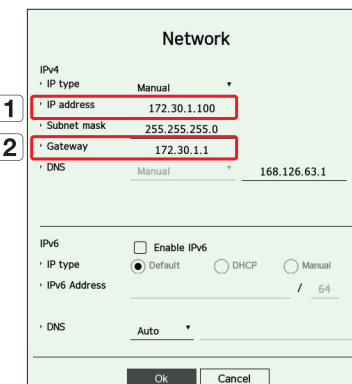

<ex. Recorder screen>

## Checking the recorder connection from the PC

Enter the IP set in the recorder menu in the local PC address bar. Once you log in by entering your user name and password, the recorder's web viewer screen appears.

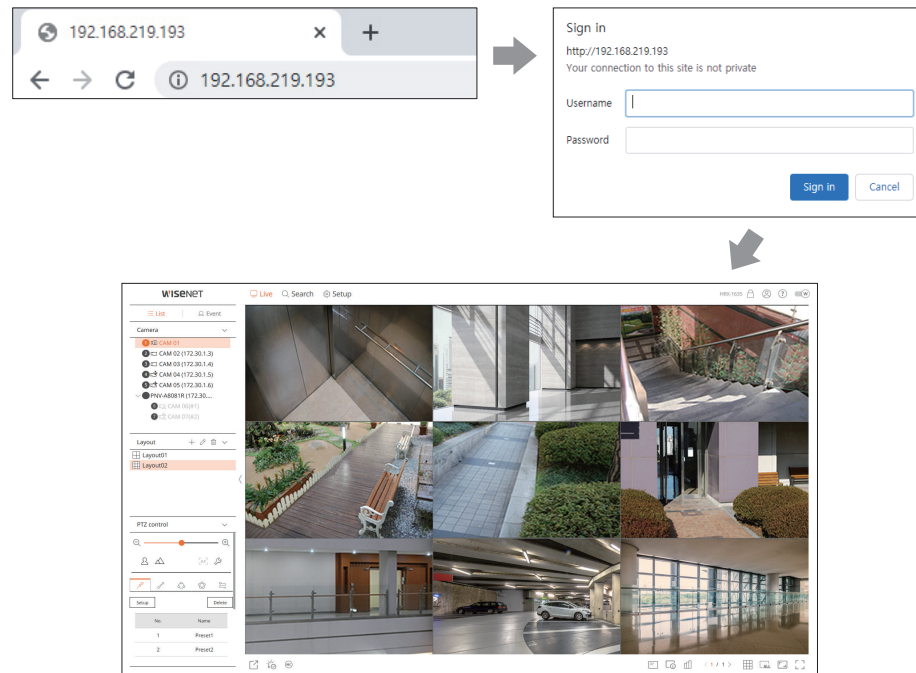

## System requirements

The following lists the minimum suggested hardware and operating system requirements needed to run the Web Viewer.

- Use the browser recommended by the OS.  
Ex.) Microsoft recommended browser: Microsoft Edge
- Supported browsers : Chrome, Edge, and Safari
- Supported OS : Works on all of the Windows, Linux, and OS X environments given the platform-independent nature of the web.
- Tested environments : Tested and certified to run on Windows® 10 with Edge 91, Google Chrome™ 91 and Intel® Core™ i7-7700 processor 3.60 Ghz with NVIDIA® GeForce® GTX™ 1050 or Intel™ HD Graphics 630.
- Performance restrictions : The performance of users' CPU/GPU may impact the video playback performance of the web viewer. The video quality may decrease depending on the settings, such as high resolution or transfer bandwidth, when playing H.265 video in Chrome.

## Router and Internet connection setup

Since each router has a different connection method, check the settings for each router.

### Port forwarding on the router setup

Set up the router's port forwarding to connect to a PC or a recorder connected to the router's local LAN from outside.

The recorder uses the <RTSP port>, <HTTP port>, <HTTPS port>, and camera proxy ports. You must set up port forwarding for all the ports you use.

- ※ If only <HTTP port> is set for port forwarding, <RTSP port>, which is a video transmission port, is connected, but no video is displayed.
- ※ If only <RTSP port> is set for port forwarding, no connection is available because <HTTP port>, which is a web connection port, is connected.
- ※ Refer to the router's user manual.



Hanwha Techwin cares for the environment at all product manufacturing stages, and is taking measures to provide customers with more environmentally friendly products.

The Eco mark represents Hanwha Techwin's devotion to creating environmentally friendly products, and indicates that the product satisfies the EU RoHS Directive.

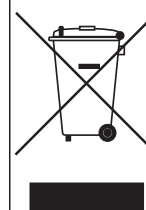

#### **Correct Disposal of This Product** (Waste Electrical & Electronic Equipment)

(Applicable in the European Union and other European countries with separate collection systems)

This marking on the product, accessories or literature indicates that the product and its electronic accessories (e.g. charger, headset, USB cable) should not be disposed of with other household waste at the end of their working life. To prevent possible harm to the environment or human health from uncontrolled waste disposal, please separate these items from other types of waste and recycle them responsibly to promote the sustainable reuse of material resources.

Household users should contact either the retailer where they purchased this product, or their local government office, for details of where and how they can take these items for environmentally safe recycling.

Business users should contact their supplier and check the terms and conditions of the purchase contract. This product and its electronic accessories should not be mixed with other commercial wastes for disposal.



#### **Correct disposal of batteries in this product**

(Applicable in the European Union and other European countries with separate battery return systems.)

This marking on the battery, manual or packaging indicates that the batteries in this product should not be disposed of with other household waste at the end of their working life. Where marked, the chemical symbols Hg, Cd or Pb indicate that the battery contains mercury, cadmium or lead above the reference levels in EC Directive 2006/66. If batteries are not properly disposed of, these substances can cause harm to human health or the environment.

To protect natural resources and to promote material reuse, please separate batteries from other types of waste and recycle them through your local, free battery return system.

